

Data Sheet



Article number: 0125087

Description: Retaining ring SP80
Spring steel

Measures

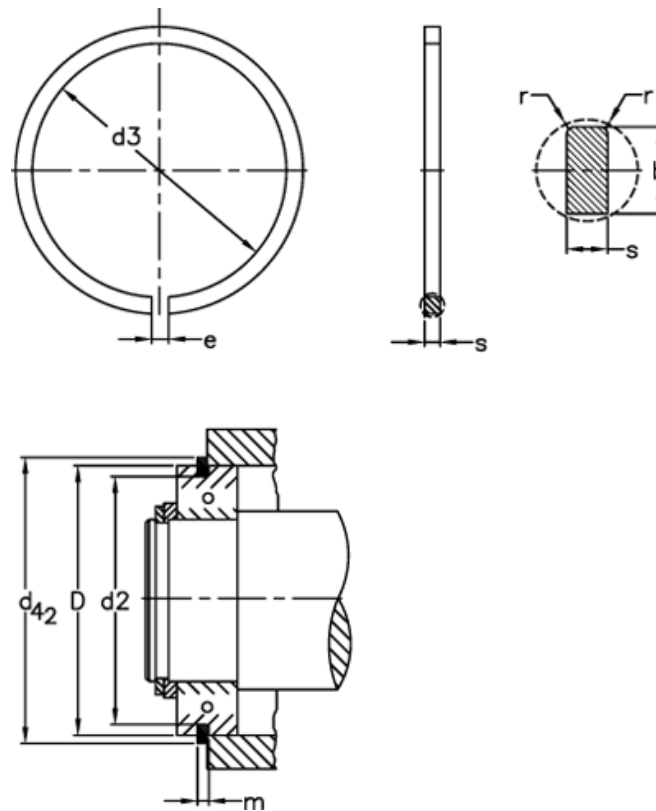

b	= 4.85	FRg kN	= 5.25	tol	= -0.15
D	= 80	FR kN	= 34.8	tol	= -0.1
d2	= 76.81	g	= 3.0	tol	= -0.50
d3	= 75.4	K kN-mm	= 64.0	tol	= 0.3
d42	= 86.6	m	= 1.90	tol	= 0.8
Description	= SP 80	n abl x 1000	= 3.0	Weight kg/1000	= 16.3
e	= 5	r min	= 0.6		
FN kN	= 65.7	s	= 1.70		